







META Concealed two-way diverter - Brushed Platinum

META

36 200 661



- rotary diverter
- without rosette
- handle Ø 60mm

	Brushed Platinum	36 200 661-06
	Chrome	36 200 661-00
	Dark Chrome	36 200 661-19
	Matte Black	36 200 661-33
	Brushed Champagne (22kt Gold)	36 200 661-46
	Champagne (22kt Gold)	36 200 661-47
	Brushed Chrome	36 200 661-93

Required miscellaneous



- Concealed two-way diverter -** 35 202 970 90
- max. recess depth 160 mm
 - min. recess depth 115 mm

36 200 661

mm [inches]

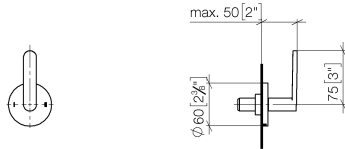

Flow rate chart



Certificates

LGA_38379.

WRAS_2307045.

36 200 661

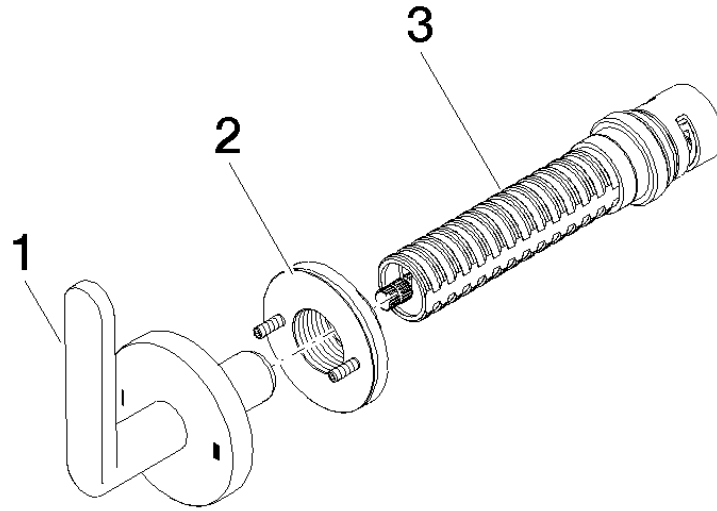

Spare parts list

No.	Item Number	Name	Quantity used	Delivery time
1	90 20 66 014 00-06	handle	1	10
2	90 21 02 181 00 90	disc	1	2
3	90 90 03 304 10 90	diverter	1	2