







36 607 819

- rosette Ø 60 mm
- head part with cut-to-length spindle and sleeve



	Brushed Platinum	36 607 819-06
	Chrome	36 607 819-00
	Platinum	36 607 819-08
	Dark Chrome	36 607 819-19
	Brushed Durabronze (23kt Gold)	36 607 819-28
	Brushed Champagne (22kt Gold)	36 607 819-46
	Champagne (22kt Gold)	36 607 819-47
	Brushed Dark Platinum	36 607 819-99

Required miscellaneous



- Wall valve 1/2" -** 35 607 970 90
- max. recess depth 145 mm
  - min. recess depth 75 mm

36 607 819

mm [inches]

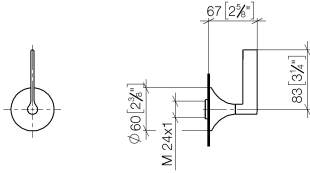

Certificates

DVGW\_DW-  
6501DN0116.

WRAS\_2011026.

IAPMO\_4976 (1).

LGA\_29931.

WRAS\_2010066.

DVGW\_DW-  
6512DN0706.

LGA\_29932.

36 607 819

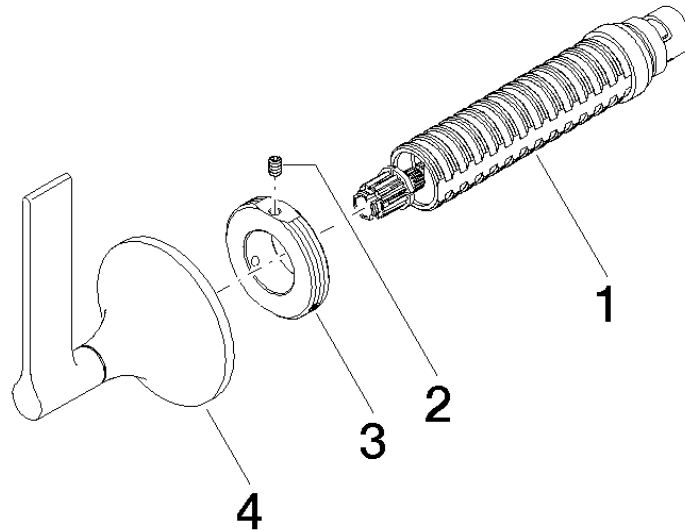

### Spare parts list

No.	Item Number	Name	Quantity used	Delivery time
1	90 90 03 143 00 90	top	1	2
2	09 31 11 008 90	pin	1	2
3	09 21 02 163 90	disc	1	2
4	90 20 80 015 00-06	handle	1	10