

WATER FALL Cascade spout with individual jets for wall mounting - Brushed Platinum









IMO

13 425 979



- 22mm projection
- PEARLSTREAM
- plate 240 mm x 60 mm
- connection 1/2", for shortening
- plug-link mounting
- Max. flow rate 9.5 l/min (at 3 bar)

Fits: IMO, LULU, MADISON, MEM, TARA, CL.1, LISSÉ, VAIA, META, CYO

	Brushed Platinum	13 425 979-06
	Chrome	13 425 979-00
	Platinum	13 425 979-08
	Dark Chrome	13 425 979-19
	Brushed Durabrass (23kt Gold)	13 425 979-28
	Matte Black	13 425 979-33
	Brushed Champagne (22kt Gold)	13 425 979-46
	Champagne (22kt Gold)	13 425 979-47
	Brushed Dark Platinum	13 425 979-99

Recommended miscellaneous



Concealed wall elbow -

- max. recess depth 163 mm
- min. recess depth 90 mm

35 085 970 90

Recommended miscellaneous



Concealed wall elbow -

- max. recess depth 163 mm
- min. recess depth 90 mm

35 085 970 90

13 425 979
mm [inches]

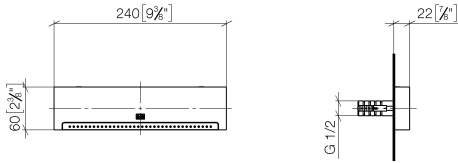

Flow rate chart

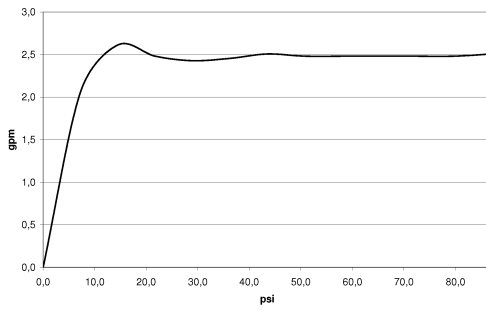

Trajectory diagram

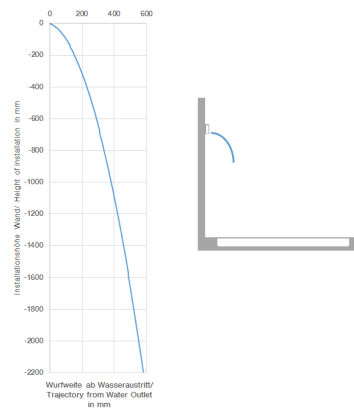

Certificates

LGA_19935.

IAPMO_4976 (6).

13 425 979

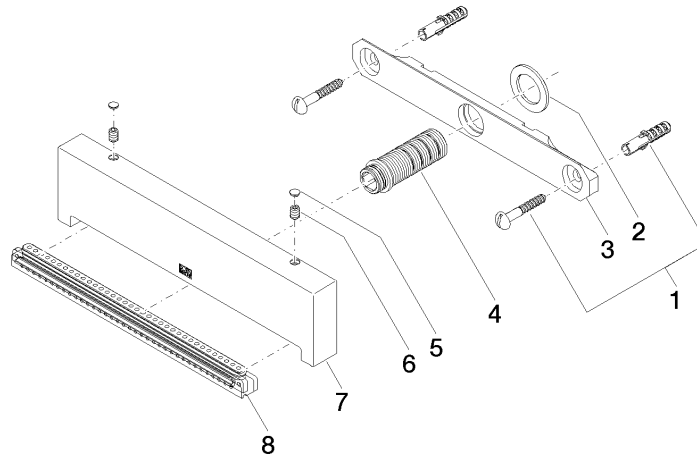

Spare parts list

No.	Item Number	Name	Quantity used	Delivery time
1	04 30 31 024 01 90	fixing set	1	2
2	09 14 05 009 90	seal	1	2
3	09 17 97 053 90	holder	1	2
4	90 24 03 199 00 90	connection	1	2
5	90 31 20 087 00-06	plug	1	10
6	09 31 11 144 90	pin	2	2
8	90 29 03 071 00 90	insert	1	2